

This article was downloaded by:

On: 24 January 2011

Access details: *Access Details: Free Access*

Publisher *Taylor & Francis*

Informa Ltd Registered in England and Wales Registered Number: 1072954 Registered office: Mortimer House, 37-41 Mortimer Street, London W1T 3JH, UK



Journal of Macromolecular Science, Part A

Publication details, including instructions for authors and subscription information:

<http://www.informaworld.com/smpp/title~content=t713597274>

Effect of Atmospheres on Stabilization of Polyacrylonitrile Fibers

Tongqing Sun^{ab}; Yongping Hou^{ab}; Haojing Wang^a

^a Institute of Coal Chemistry, Chinese Academy of Sciences, Taiyuan, People's Republic of China ^b

Graduate University of Chinese Academy of Sciences, Beijing, People's Republic of China

To cite this Article Sun, Tongqing , Hou, Yongping and Wang, Haojing(2009) 'Effect of Atmospheres on Stabilization of Polyacrylonitrile Fibers', *Journal of Macromolecular Science, Part A*, 46: 8, 807 – 815

To link to this Article: DOI: 10.1080/10601320903004657

URL: <http://dx.doi.org/10.1080/10601320903004657>

PLEASE SCROLL DOWN FOR ARTICLE

Full terms and conditions of use: <http://www.informaworld.com/terms-and-conditions-of-access.pdf>

This article may be used for research, teaching and private study purposes. Any substantial or systematic reproduction, re-distribution, re-selling, loan or sub-licensing, systematic supply or distribution in any form to anyone is expressly forbidden.

The publisher does not give any warranty express or implied or make any representation that the contents will be complete or accurate or up to date. The accuracy of any instructions, formulae and drug doses should be independently verified with primary sources. The publisher shall not be liable for any loss, actions, claims, proceedings, demand or costs or damages whatsoever or howsoever caused arising directly or indirectly in connection with or arising out of the use of this material.

Effect of Atmospheres on Stabilization of Polyacrylonitrile Fibers

TONGQING SUN^{1,2,*}, YONGPING HOU^{1,2} and HAOJING WANG¹

¹Institute of Coal Chemistry, Chinese Academy of Sciences, Taiyuan 030001, People's Republic of China

²Graduate University of Chinese Academy of Sciences, Beijing 100049, People's Republic of China

Received December 2008, Accepted February 2009

The effect of atmospheres on stabilization of polyacrylonitrile (PAN) fibers was studied by free shrinkage experiments, Fourier transform infrared spectrometer (FT-IR), elemental analysis, metallographic microscope and tensile testing analysis. FT-IR spectra and elemental analysis of heat treated PAN fibers showed that three main reactions took place, namely cyclization, dehydrogenation and oxidative reactions in oxygen-containing atmospheres. Two main reactions took place, namely cyclization, dehydrogenation reactions in pure nitrogen. The shrinkage indicated that there was crosslinking reaction in oxygen-containing atmospheres. The shrinkage also showed that the chemical shrinkage increased with the increase of oxygen contents in atmospheres. Atmospheres had a sizeable effect on the skin-core structure and tensile strength. When oxygen contents in atmospheres were 20%, 50%, 70% and 100%, the thickness of the outer rings of the skin-core structure increased quickly. The core area continued to decrease and finally almost disappeared. Also, PAN fibers which were stabilized in pure nitrogen did not have skin-core structure. In the oxygen contents which were 20%, 50%, 70% and 100%, the tensile strength decreased quickly. The tensile strength of stabilized PAN fibers in nitrogen was not the lowest.

Keywords: PAN fibers, shrinkage, skin-core morphology, tensile strength

1 Introduction

PAN fibers are the most widely used precursors for producing carbon fibers for a variety of reasons. The manufacture of PAN-based carbon fibers usually undergoes three indispensable processes: spinning of precursor fiber, stabilization, and carbonization. However, it is the stabilization step prior to carbonization that has the largest impact on the quality of the final fibers. In practice, heating the precursors to the temperatures in the range of 180–300°C produces a species that is exceptionally heat resistant and will not melt or fuse when subsequently carbonized at the high temperature (1000–2000°C) (1–3). During stabilization, PAN fibers undergo various physical and chemical changes, such as cyclization, dehydrogenation, crosslinking reaction, diffusion and incorporation of oxygen, coloration and shrinkage of fibers. These physical and chemical changes depend strongly upon thermal stabilization parameters, e.g. temperature, heating rate, atmospheres, duration time and

stretching ratios (4–6). Among these parameters, atmosphere is an important stabilization parameter. Therefore, the choice of atmosphere is also very important. Normally, air is typically the medium of choice. Non-air atmospheres have also been tried (7–14). For example, stabilization has been carried out in vacuum, oxygen, sulphur (15) or other oxidizing gases. However, stabilization carried out in the mixed gases of oxygen and nitrogen has been reported rarely.

In this article, the behavior of the shrinkage during stabilization of PAN fibers was measured. The effects of atmospheres on the chemical reactions, chemical shrinkage, structure evolution, skin-core structure and tensile strength of PAN fibers are discussed.

2 Experimental

2.1 Materials

The selected PAN precursor was supplied by Hui-Tong Ltd. (Yangzhou, China) containing 3000 filaments with an average denier of 1.18 g/cc and a mean diameter of 12.4 μm. This precursor fiber was most probably a copolymer of acrylonitrile, methylacrylate, and itaconic acid. The designation a is given to the precursor fiber.

*Address correspondence to: Tongqing Sun, Institute of Coal Chemistry, Chinese Academy of Sciences, Taiyuan 030001, People's Republic of China and Graduate University of Chinese Academy of Sciences, Beijing 100049, People's Republic of China. E-mail: tongqingsun1981@yahoo.cn

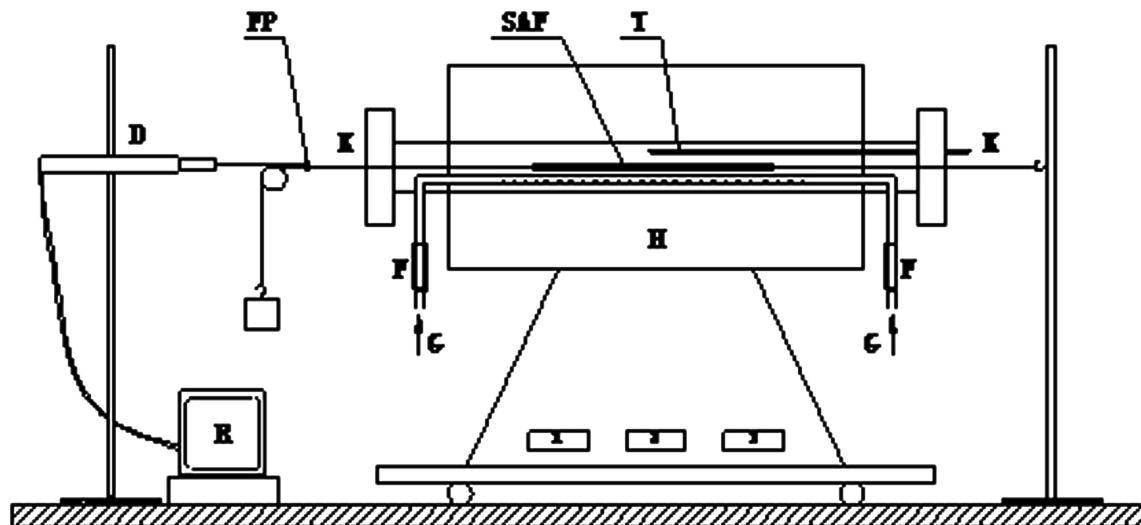

Fig. 1. Apparatus used for thermal strain measurements: SAF–PAN Fiber T–Thermocouple K–Kevlar FP–Fixed Point F–Flowmeter G–Purge Gas D–Displacement Pickup H–3-Zone Furnace R–paperless recorder.

2.2 Thermal Stabilization

Stabilization was carried out in a batch scale furnace (Fig. 1). The furnace temperature was measured by a thermocouple placed in the furnace tube. For constant tension modes experiments, the precursor fiber was free to shrink and stabilization was carried out by continuously flowing the mixed gases or nitrogen (3.3 L/min). The heat treatment temperature varied from 20°C to 300°C at a heating rate of 2°C/min. The oxygen contents in atmospheres were 0%, 20%, 50%, 70% and 100%. The designations b–f are given to the five samples.

2.3 Measurement and Characterization

In the shrinkage experiments, a fixed length of precursor fiber was tied to Kevlar thread on both ends. One end of the Kevlar thread was rigidly fixed and the other end was passed over a smooth pulley to a weight, corresponding to a tension of 0.0013 cN/dtex. The movement of the weight was monitored by a displacement pickup, and converted to the shrinkage values. Results obtained were referred to as free shrinkage, since the tension on the fibers was extremely small. The change of the Kevlar length was negligible in the range of temperatures studied. Output from the displacement pickup was amplified and noted by a paperless apparatus recorded every second. The density of various fibers was obtained at 25°C with the gradient column. The column consisted of a mixture of toluene ($d = 0.866$ g/cc) and carbon tetra chloride ($d = 1.585$ g/cc) with a gradient of 1.00–1.60 g/cc. Infrared spectra was performed to observe the effect of atmospheres. FT-IR measurements were made on a Nicolet Magna 550 Fourier transform infrared spectrometer using a resolution of 2 cm^{-1} and 64 scans per sample. For a partially-stabilized sample, an FT-IR

conversion index may be defined in terms of the intensities of these peaks (16), as

$$A_I = I_A / (I_A + I_P) \quad (1)$$

Where I_A was the measured intensity of the conjugated band at 1600 cm^{-1} , associated with the developing structure, and I_P was that of the nitrile band at 2240 cm^{-1} . Tensile testing was carried out using a YD-001D Instron tensile testing machine, with a cross head speed of 1 cm/min. In each case, a minimum number of twenty-five filaments with a gauge length of 2 cm were used for the measurement of tensile and their averages were reported here. Every sample was viewed at $\times 1000$ magnification in a metallographic microscope for the diameter measurements. Percentages of carbon, hydrogen and nitrogen for various samples were determined on a Vario elemental analyzer. Percentage oxygen was then determined by the difference. Since the stabilized sample was extremely hygroscopic, it should be dried thoroughly at about 100°C for nearly one hour before subjecting them to elemental analysis. The cross section of stabilized fibers was observed by a CMM-55 metallographic microscope. Before observation, the fibers were embedded in epoxy 6101 resin, cured, and then made into a 0.5 mm section in thickness.

3 Results and Discussion

3.1 Effect of Atmospheres on Free Shrinkage

PAN fibers undergo characteristic shrinkage with the increase of temperature during stabilization. The shrinkage is considered to consist of two categories: physical and chemical shrinkage (17). Figure 2 shows the shrinkage of PAN fibers in the mixed gases with various oxygen contents. It is

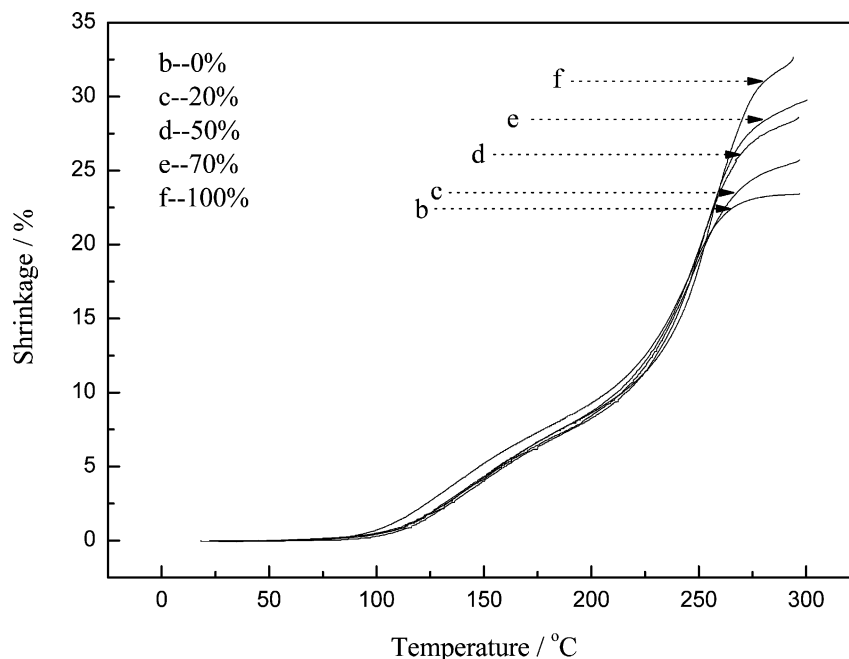

Fig. 2. Changes of shrinkage on heating in atmospheres with various oxygen contents: (b) 0% (c) 20% (d) 50% (e) 70% (f) 100%.

immediately apparent that stabilization atmosphere has a great impact on the development of shrinkage at high temperatures. When the temperature is below 180°C, the linear PAN macromolecules mainly undergo physical changes which lead to the physical shrinkage due to the relaxation of molecular chains in the disordered phase of PAN fibers (18); it is not affected by ambient atmospheres. When the temperature is above 180°C, PAN fibers undergo chemical changes which lead to the chemical shrinkage (18). Examination of Figure 2 appears to indicate that the shrinkage curves increase quickly above 180°C. These curves are almost superposable in the range of 180–250°C. At about 250°C, the shrinkage curves are divided into two parts: b, c and d, e, f. In succession, all of these curves diverge at about 258°C, separately. After about 258°C, these curves are largely affected by oxygen contents in atmospheres.

During stabilization, the physical and chemical shrinkage can be clearly distinguished by a minimum in the first derivative curve (19). Figure 3 is the typical shrinkage curve measured during stabilization with small load, composed of contributions from physical shrinkage and chemical reaction shrinkage. According to Figure 3, the chemical shrinkage can be confirmed.

Figure 4 indicates the changes of chemical shrinkage on heating in atmospheres with various oxygen contents. As shown in Figure 4, the chemical shrinkage increases quickly (b-f). So, the chemical shrinkage is largely affected by oxygen contents in atmospheres.

According to Figure 3, the final temperature (T_f) can also be confirmed. The T_f during stabilization in the mixed gases are shown in Table 1. The effect of atmospheres on T_f is very obvious. The T_f increases gradually (b-f),

that is, with the increase of oxygen contents, the T_f is postponed.

3.2 Effect of Atmospheres on the Structure Evolution

FT-IR has been used to study the structural evolution of PAN fibers. Figure 5 shows the relevant spectral features for the five samples, in the wavenumber range 400–4000 cm^{-1} . From this figure, it is recognized that the absorption band of 2240 cm^{-1} assigned to the nitrile group, and 2939 cm^{-1} assigned to the methylene (20) have decreased drastically (b-f), compared with the precursor fiber, and that of the absorption bands of 1600 cm^{-1} assigned to C=N and C=C group (20) has increased enormously. This indicates the formation of cyclic conjugation leading to a dehydropyridine type structure (21). The band at 810 cm^{-1} assigned to CH out-of-plane bending vibration (22–24) appears to be the characteristic of oxygen-containing atmospheres oxidized material. However, it is also observed in nitrogen stabilized PAN fibers. In addition to the above, these observations show that various and complicated chemical structures produce with the progress of stabilization.

Figure 6 shows the changes of aromatization index in atmospheres with various oxygen contents. The values of

Table 1. Properties of the stabilized fibers in different atmospheres

Oxygen contents in atmospheres (%)	0	20	50	70	100
T_f (°C)	263	267	269	271	275

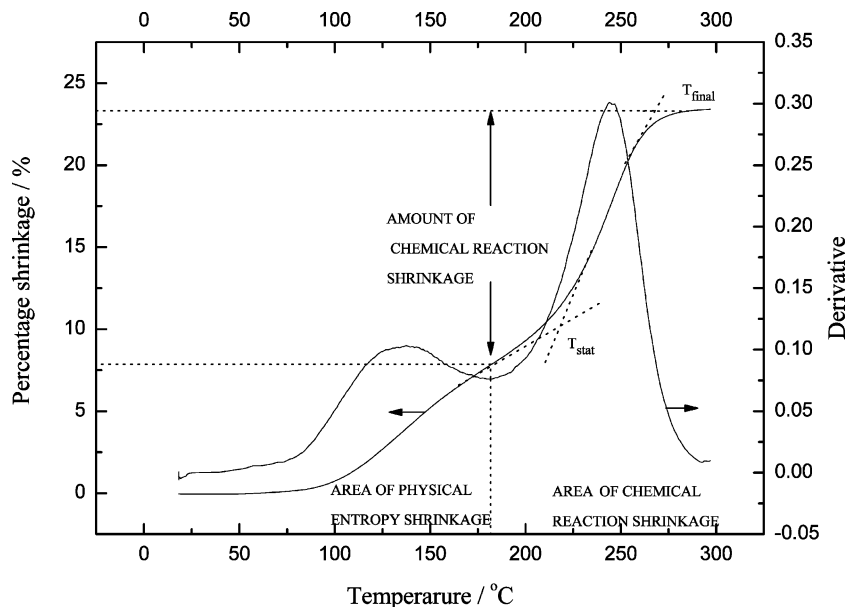

Fig. 3. Typical shrinkage curve measured during stabilization with small load, composed of contributions from physical shrinkage and chemical reaction shrinkage.

A_I increase proportionately with the increase of the oxygen contents, but in pure nitrogen, and the value of A_I in pure nitrogen is not the lowest. This is because the process of stabilization is diffusion and reaction controlled (25). In oxygen-containing atmospheres, oxygen plays an important role during stabilization. Oxygen can facilitate the chemical reaction (25). Therefore, the diffusion of oxygen is predominant in controlling stabilization. The higher

the oxygen content, the higher the diffusion rate, and the higher the value of the A_I . On the other hand, there is no oxygen in nitrogen. The cyclized structure in the fibers is formed rapidly by the chain-transfer reaction with the thermal energy (5), therefore, the reaction mechanism is different from that of oxygen-containing atmospheres. The progress of stabilization is reaction controlled in nitrogen.

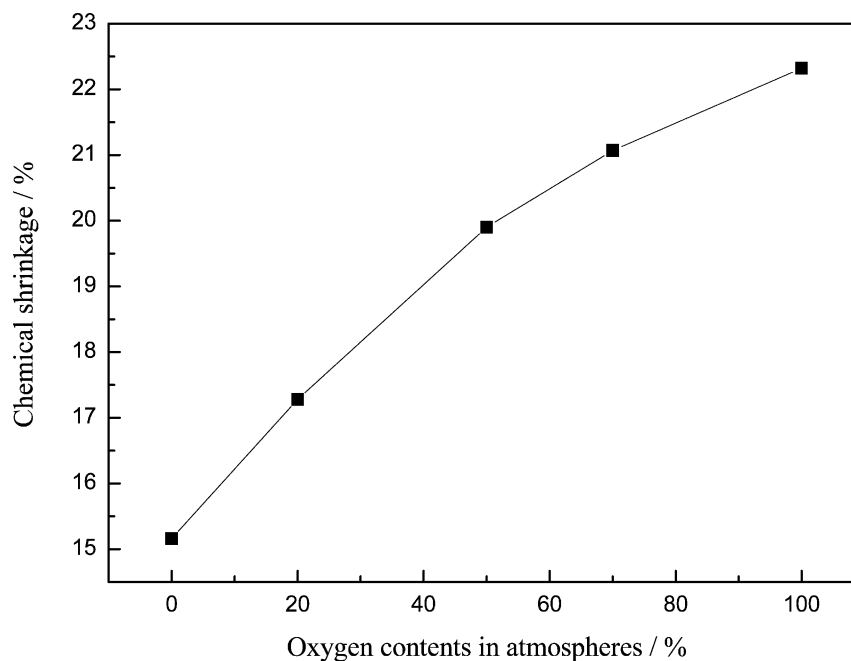

Fig. 4. Changes of chemical shrinkage on heating in atmosphere with various oxygen contents.

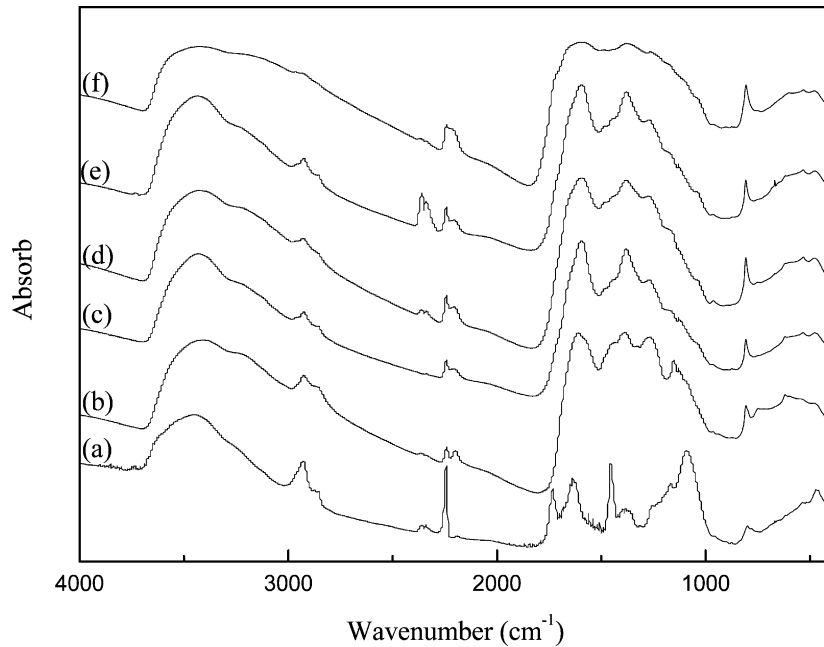

Fig. 5. IR spectra of the fibers in atmospheres with various oxygen contents: (a) PAN fiber (b) 0% (c) 20% (d) 50% (e) 70% (f) 100%.

3.3 Effect of Atmospheres on Density and Elemental Composition

Figure 7 is the effect of atmospheres with various oxygen contents on density of the stabilized fibers. Figure 8 shows variation of H and O on heating in atmospheres with various oxygen contents. From Figures 7 and 8, it is recognized that the densities and oxygen contents of the stabilized

fibers increase quickly (b-f). However, the hydrogen contents of the stabilized fibers decrease quickly (b-f).

3.4 Effect of Atmospheres on the Skin-Core Structure and Tensile Strength

When PAN fibers are heat treated, the surface color will change from white to yellow, brown and eventually black

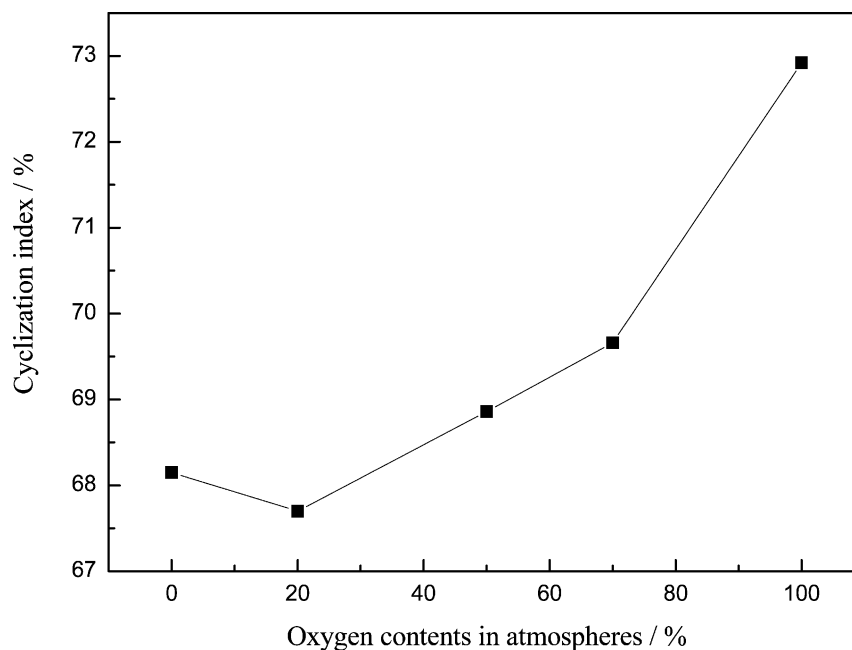

Fig. 6. Changes of cyclization index in atmospheres with various oxygen contents.

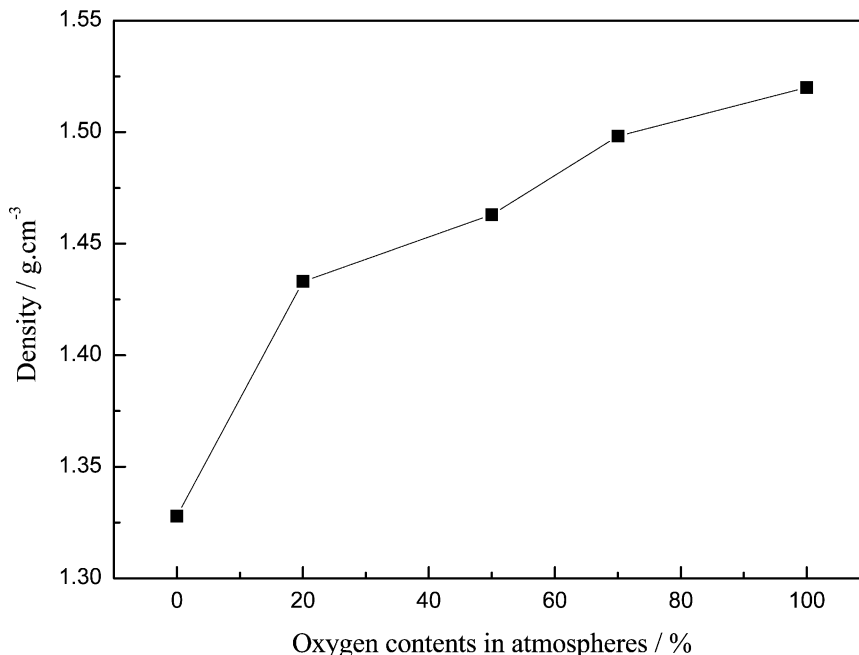

Fig. 7. Effect of atmospheres with various oxygen contents on the densities of the stabilized fibers.

with the rising of temperature or the increasing of heating time (4, 26). The inner color has been observed as heterogeneous by some researchers using optical morphology (27–29). It is very clear that the outer skin and inner core is different. This is the skin-core structure. In the thermal stabilization process, the skin-core structure is controlled by thermal-treatment temperature, reaction time, atmosphere, and other conditions (28, 29). Figure 9 is the effect of atmospheres with various oxygen contents on the skin-core structure of the stabilized fibers. According to this figure, it

is very clear that the outer ring which is compact reflects the light. This is the far stabilized part, whereas the black core which absorbs the light is the not fully stabilized part. This is because the penetration of oxygen from the outer skin to the inner core needs some time. As soon as the dense skin is formed, the penetration rate of oxygen is lowered. Because the skin increases the barrier of oxygen to further diffusion across the layer, it will result in longer times for full stabilization of the fibers. From Figure 9, it is recognized that the thickness of the outer rings increase (c-f). In pure oxygen,

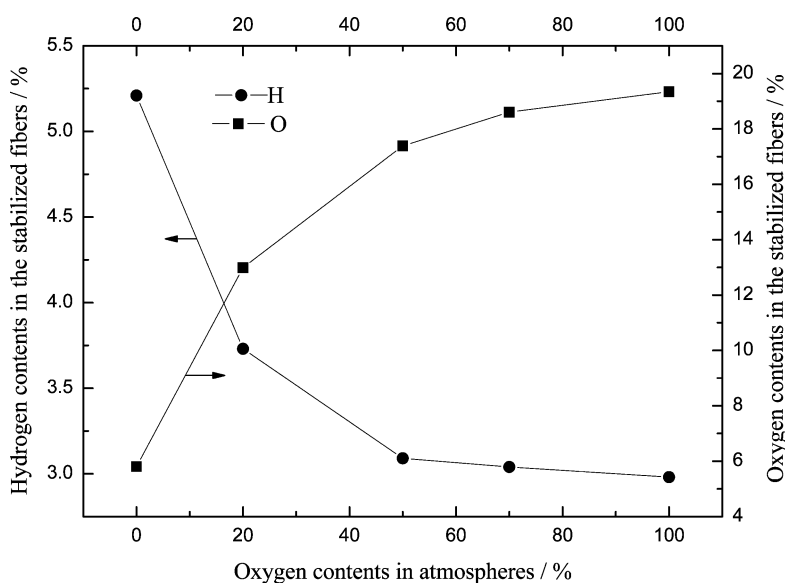

Fig. 8. Variation of H and O on heating in atmospheres with various oxygen contents.

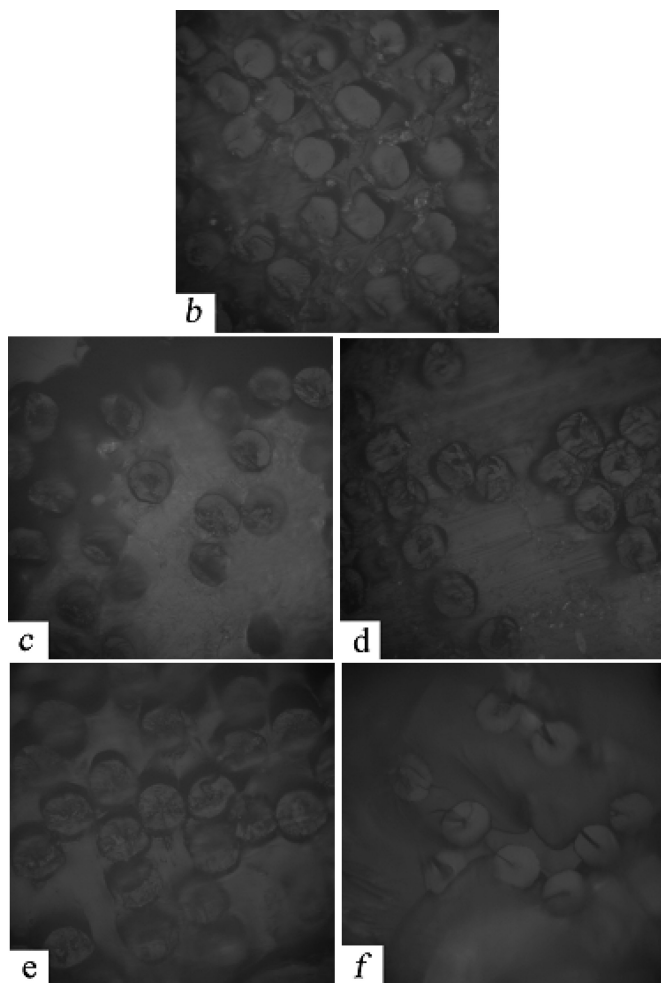

Fig. 9. Effect of atmospheres with various oxygen contents on skin-core structure of the stabilized fibers: (b) 0%, (c) 20%, (d) 50%, (e) 70%, (f) 100%.

the stabilized fiber barely has the skin-core structure. As mentioned above, the process of stabilization is diffusion controlled by oxygen in the mixed gases. The higher the oxygen content, the higher the diffusion rate. Therefore, the thickness of the outer rings increases quickly. The core area continues to decrease and finally almost disappears. It is, therefore, very clear that there is no diffusion of oxygen and oxygen gradient in PAN fibers treated in nitrogen. So, the stabilized fiber is also homogeneous in nitrogen.

Figure 10 presents the relationship between the oxygen contents in the mixed gases and tensile strength of the stabilized fibers. From Figure 10, it is recognized that the tensile strength decreases (c-f), but in nitrogen.

To the total shrinkage of the stabilized fibers, if there is no crosslinking reaction during stabilization, the overall shrinkage is about 25% (30). If there is a crosslinking reaction, it can lead to the increase of the chemical shrinkage, density and A_1 value of the stabilized fibers (18, 19, 31). In our experiment, the overall shrinkage is higher than 25%

(c-f). In the presence of oxygen, the total shrinkage reaches about 32% (f). And the densities, A_1 value of the stabilized fibers increase quickly (c-f) (Figs. 5, 6 and 8). All these phenomena indicate that there is a crosslinking reaction in oxygen-containing atmospheres. The total shrinkage is less than 25% in the presence of nitrogen (b). So, there is no crosslinking reaction in the presence of nitrogen. As mentioned above, there are absorption bands at 1600 cm^{-1} assigned to C=N and C=C group and at 810 cm^{-1} assigned to CH out-of-plane bending vibration (b-f) (Fig. 5). And the hydrogen contents decrease quickly (b-f) (Fig. 7). This leads us to believe that there are cyclization and dehydrogenation reactions (b-f) (Fig. 5). The oxygen contents and density of the stabilized fibers increase quickly (Figs. 7 and 8). These phenomena indicate that there is an oxidative reaction in oxygen-containing atmospheres.

In addition to the above, we can conclude that there are cyclization, dehydrogenation, crosslinking and oxidation reactions during stabilization in oxygen-containing atmospheres. In pure nitrogen, there are only cyclization and dehydrogenation reactions. At the lower temperature, cyclization is an important reaction (18). However, crosslinking reaction begins to take place at the higher temperature in the oxygen-containing atmospheres (17). During stabilization, cyclization and crosslinking reactions can lead to the shrinkage (17). Therefore, we only talk about the cyclization reaction in the range of $180\text{--}250^\circ\text{C}$ (b-f). If the cyclization reaction is largely affected by oxygen contents in this temperature range, the chemical shrinkage, which is caused by cyclization reaction, will be much different. However, these curves are almost superposable in this temperature range. Therefore, we have a result that the cyclization reaction is not affected in the temperature range $180\text{--}250^\circ\text{C}$. This is because the crosslinking reaction is largely affected by oxygen contents in atmospheres and temperature (17). So, the crosslinking reaction in oxygen-containing atmospheres may begin to take place from about 250°C to about 258°C . In general, the higher the oxygen content, the more crosslinking reactions there are, then these curves begin to be detached b, c, and d, e, f. After 258°C , these curves are detached, separately. On the other hand, the T_f is postponed (b-f) (Table 1). This is the other reason that the amount of crosslinking reaction increases (b-f), and this is a reason that the overall chemical shrinkage increase.

It is well known that oxygen can facilitate the chemical reaction during stabilization (18). In our experiment, it is very clear that oxygen can facilitate the dehydrogenation reaction (Figs. 5 and 8). During stabilization, there is an oxidative reaction in oxygen-containing atmospheres; the diffusion and incorporation of oxygen process will take place. With the increase of oxygen contents in atmospheres, the amount of oxidative reaction increases (c-f), therefore, this process can lead to the increase of oxygen contents and density of the stabilized fibers. The amount of crosslinking reaction increases with the increase of oxygen contents in atmospheres. Therefore, all these factors can lead to the

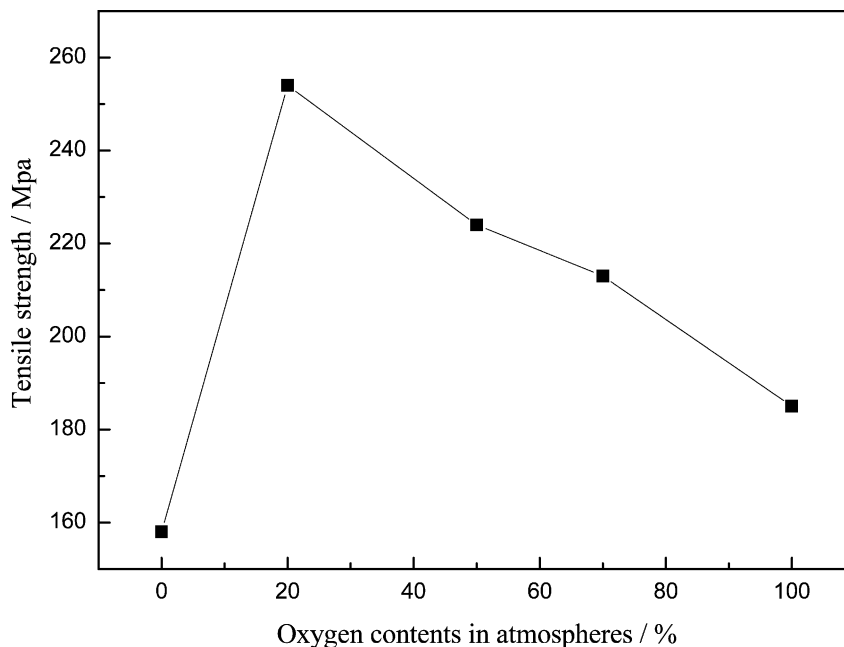

Fig. 10. Relationship between oxygen contents in the mixed gas and tensile strength of the stabilized fibers.

increase of the stabilization extents (c-f). This is the important reason that the extents of the skin-core structure decrease (c-f).

During stabilization, the tensile strength increases with the increase of the amount of the crosslinking reaction (31). However, the result is contrary in this article. This is probably because the cohesive energy resulting from induced dipoles between chains owing to the highly polar pendant $-\text{C}\equiv\text{N}$ groups is very great. Conversion of $-\text{C}\equiv\text{N}$ to $-\text{C}=\text{N}-$ upon stabilization implies a loss of interchain cohesive energy due to a loss in inter-chain dipole interactions (19), which would cause the decrease of the tensile strength. Therefore, the higher the value of A_1 in the presence of oxygen, the lower the cohesive energy, the lower the tensile strength. On the other hand, there is an oxidative degradative reaction (18). The surface of PAN fibers will be oxidized by oxygen in the mixed gas at the higher temperature, so, the surface will be partly damaged. With the increase of oxygen contents, the damage of the surface also increases. Therefore, the tensile strength is largely affected by a oxidative degradative reaction. This may be an important reason which leads to the decrease of the tensile strength (c-f). To the ultimate tensile strength, a possible reason is that the amount of the tensile strength gain, which is caused by the crosslinking reaction, is less than the amount of tensile strength loss which is caused by the loss of interchain cohesive energy and surface damage. Thus, the net tensile strength, which is the total tensile strength gain and tensile strength loss decreases (c-f). During stabilization in nitrogen, there is no crosslinking reaction. So, the tensile strength of the stabilized fibers is the lowest among the five samples.

4 Conclusions

The effect of atmospheres on the chemical reaction is that there are crosslinking and oxidative reactions during stabilization, besides dehydrogenation and cyclization in oxygen-containing atmospheres. There is also dehydrogenation in nitrogen, besides cyclization. The cyclization reaction is not affected by the oxygen contents in atmospheres in the range of 180–250°C. Therefore, the chemical shrinkage is also not largely affected by oxygen contents in this temperature range. After about 250°C, the crosslinking reaction maybe begin to take place in oxygen-containing atmospheres. The chemical shrinkage is largely affected by oxygen contents after 250°C, and the T_f is postponed. This is also a reason that the chemical shrinkage increases (b-f).

In oxygen-containing atmospheres, oxygen can facilitate dehydrogenation, crosslinking and oxidation reactions, and the process of stabilization is diffusion controlled. Therefore, the skin-core morphology is largely affected by the oxygen contents. The thickness of the outer rings increases quickly (c-f). The core area continued to decrease and finally almost disappears. The process of stabilization is reaction controlled in nitrogen. Hence, the skin-core morphology is not obvious. The higher the oxygen content, the lower the tensile strength, but in pure nitrogen. The tensile strength is the lowest among the five samples.

References

1. Catta Preta, I.F., Sakata, S.K., Garcia, G., Zimmermann, J.P., Galembek, F. and Giovedi, C. (2007) *Journal of Thermal Analysis and Calorimetry*, 87(3), 657–659.

2. Sedghi, A., Farsani, R.E. and Shokuhfar, A. (2007) *Journal of Materials Processing Technology*, 198(1–3), 60–67.
3. Rahaman, M.S.A., Ismail, A.F. and Mustafa, A. (2007) *Polymer Degradation and Stability*, 92(8), 1421–1432.
4. Dalton, S., Heatley, F. and Budd, P.M. (1999) *Polymer*, 40(20), 5531–5543.
5. Ogawa, H. and Satto, K. (1995) *Carbon*, 33(6), 783–788.
6. Ko, T.H., Ting, H.Y. and Lin, C.H. (1988) *J. Appl. Polym. Sci.*, 35(4), 863–874.
7. Jain, M.K. and Abhiraman, R.C. (1987) *J. Mater. Sci.*, 22(1), 278–300.
8. Donnet, J.B., Bansal, R.C. and Bahl, O.P. Academic Press: New York, 1992.
9. Damodaran, S., Desai, P. and Abhiraman, A.S. (1990) *J. Text. Inst.*, 81(4), 384–420.
10. Clarke, J.A. and Bailey, J.E. (1973) *Nature*, 243, 146–150.
11. Bahl, O.P. and Manocha, L.M. (1975) *Die. Angew. Macromol. Chemie.*, 48, 145–159.
12. Manocha, L.M., Bahl, O.P. and Jain, G.C. (1978) *Die. Angew. Macromol. Chemie.*, 67, 11–29.
13. Bahl, O.P. and Manocha, L.M. (1975) *Carbon*, 13(4), 297–300.
14. Bahl, O.P. and Manocha, L.M. (1976) *Fibre. Sci. Technol.*, 9(1), 77–80.
15. Blazewicz, S. (1989) *Carbon*, 27(6), 777–783.
16. Zhu, Y., Wilding, M.A. and Mukhopadhyay, S.K. (1996) *J. Mater. Sci.*, 31(14), 3831–3837.
17. Wang, P.H., Liu, J. and Li, R.Y. (1998) *J. Appl. Polym. Sci.*, 67(7), 1185–1190.
18. Gupta, A. and Harrison, I.R. (1997) *Carbon*, 35(6), 809–818.
19. Fitzer, E., Frohs, W. and Heine, M. (1986) *Carbon*, 24(4), 387–395.
20. Mittal, J., Bahl, O.P., Mathur, R.B. and Sandle, N.K. (1994) *Carbon*, 32(6), 1133–1136.
21. Wang, P.H., Liu, J. and Li, R.Y. (1994) *J. Appl. Polym. Sci.*, 52(12), 1667–1674.
22. Coleman, M.M. and Petcavich, R.J. (1978) *J. Polym. Sci.-Polym. Phys. Ed.*, 16(5), 821–832.
23. Conley, R.T. and Bieeron, J.F. (1963) *J. Appl. Polym. Sci.*, 7(5), 1757–1773.
24. Liepins, R., Campbell, D. and Walker, C. (1968) *J. Polym. Sci.*, A1–6, 3059.
25. Warmer, S.B., Peebles, L.H. and Uhlmann, D.R. (1979) *J. Mater. Sci.*, 14(3), 556–564.
26. Grassie, N. and McNeill, I.C. (1958) *J. Polym. Sci.*, 27(115), 207–218.
27. Zhang, W.X., Liu, J. and Liang, J.Y. (2004) *J. Mater. Sci. Technol.*, 20(4), 369–372.
28. Watt, W. and Johnson, W. (1975) *Nature*, 257, 210–212.
29. Coleman, M.M. and Sivy, G.T. (1981) *Carbon*, 19(2), 123–126.
30. Fitzer, E. and Muller, D.J. (1974) *Carbon*, 13(1), 63–69.
31. Bahl, O.P. and Manocha, L.M. (1974) *Carbon*, 12(4), 417–423.